

ecotecnico

technic

GRANITOGRES



CASALGRANDE
PADANA
THE GREEN WAY TO PAVE



technic

GRANITOGRES



FLOOR: nebraska cm 20x20 - 7⁷/₈"x7⁷/₈"

COLORI COLOURS COULEURS FARBEN

PAVIMENTI FLOORS REVÊTEMENT SOL BODENFLIESEN

grigio cenere



bianco avorio

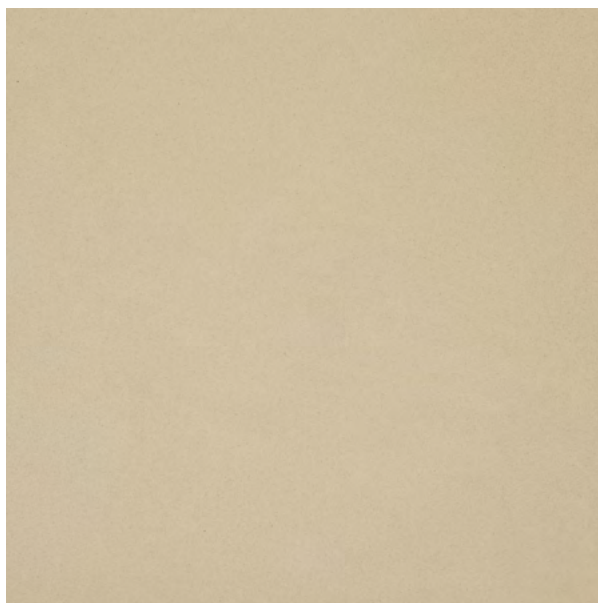

bianco B



nebraska



arkansas



ontario

technic

GRANITOGRES

RIVESTIMENTI SMALTATI GLAZED TILES REVÊTEMENT ÉMAILLÉ FLIESEN AUS GLASIERTEM FEINSTEINZEUG

Landscape tundra 100 satin



FLOOR: bianco b secura cm 20x20 - 7⁷/₈" x 7⁷/₈"

SUPERFICI SURFACES SURFACES OBERFLÄCHEN

technic R10

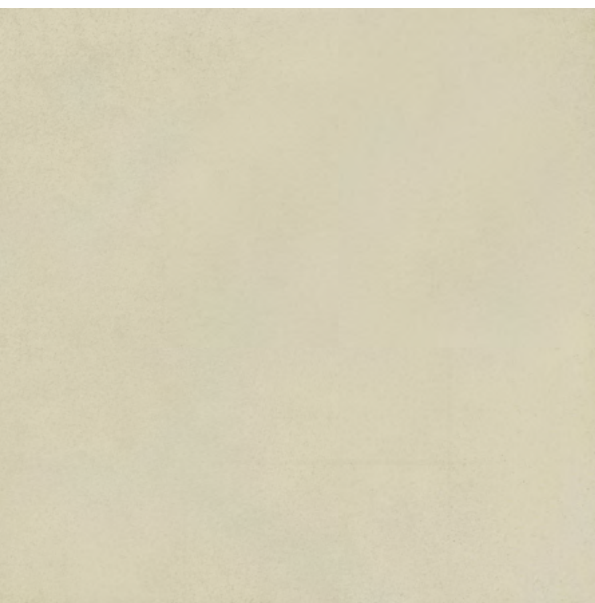

roccia R11 (A+B)



profil R12 - V8 (A+B+C)



reticolo R12 - V4 (A+B+C)



carbo R12



secura R11 (A+B)

technic

GRANITOGRES

bugnato R11 - V6 (A+B+C)

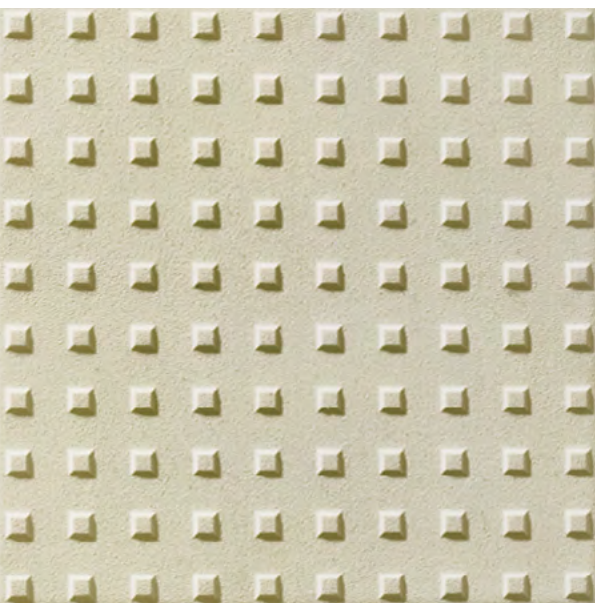



















































pavé R11 - V4 (A+B+C)



safe R13 (A+B+C)

FORMATI SIZES FORMATS FORMATE

Formati Sizes Formats Formate	 cm 20x20 7 ⁷ / ₈ "x7 ⁷ / ₈ "	 cm 20x20 7 ⁷ / ₈ "x7 ⁷ / ₈ "	 cm 20x20 7 ⁷ / ₈ "x7 ⁷ / ₈ "	 cm 12,5x25* 4 ⁷ / ₈ "x9 ⁷ / ₈ "	 cm 12,5x25* 4 ⁷ / ₈ "x9 ⁷ / ₈ "
Spessori Thicknesses Epaisseurs Stärken	mm 8	mm 12	mm 14	mm 8	mm 14
Granito 1 Arkansas					
Granito 1 Nebraska					
Granito 1 Ontario					
Unicolore Bianco Avorio					
Unicolore Bianco B					
Unicolore Grigio Genere					

Formati Sizes Formats Formate	 cm 30x30 11 ³ / ₄ "x11 ³ / ₄ "	 cm 30x30 11 ³ / ₄ "x11 ³ / ₄ "	 cm 30x30 11 ³ / ₄ "x11 ³ / ₄ "
Spessori Thicknesses Epaisseurs Stärken	mm 8	mm 11,2	mm 14
Granito 1 Arkansas			
Granito 1 Nebraska			
Granito 1 Ontario			
Unicolore Bianco Avorio			
Unicolore Bianco B			
Unicolore Grigio Genere			

* Su richiesta On request Sur demande Auf Anfrage können

Caratteristiche tecniche ed estetiche a pagina: Technical and aesthetics features on page:
 Caractéristiques techniques et esthétiques à la page : Technische und ästhetische Eigenschaften auf Seite: 479

-  Roccia **R11 A+B**
-  Bugnato **R11 A+B+C**
-  Profil **R12 A+B+C**
-  Pavé **R11 A+B+C**
-  Secura **R11 A+B**
-  Technic **R0**
-  Carbo **R12**
-  Reticolo **R12 A+B+C**
-  Safe **R13 A+B+C**

PEZZI SPECIALI TRIMS ACCESSOIRES FORMSTÜCKE

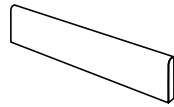

Battiscopa
Bullnose
Plinthe à bord arrondi
Stehsockel

cm 9x30
3¹/₂"x11³/₄"

cm 10x20
4"x7⁷/₈"

Formati Sizes
Formats Formate

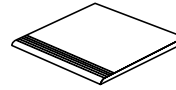

Gradino
Step tread
Nez de marche
Stufenplatte

cm 30x30
11³/₄"x11³/₄"

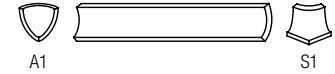

Sguscetta
Cove
Gorge
Rinnleiste

cm 4x20
1⁵/₈"x7⁷/₈"

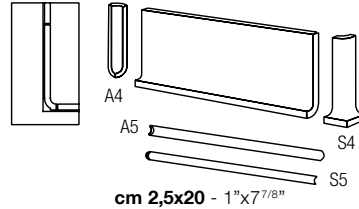

Zoccolo a raccordo a taglio retto
Cove base - straight top
Plinthe à gorge avec bord vif
Hohlkehlssockel (scharfkantig)

cm 10x20
4"x7⁷/₈"

Formati Sizes
Formats Formate

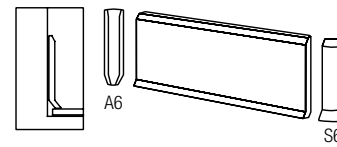

Zoccolo ad appoggio smussato
Sit-on skirting - bevelled top
Plinthe à talon avec bord arrondi
Aufsetzsockel mit abgerundeter Kante

cm 10x20
4"x7⁷/₈"

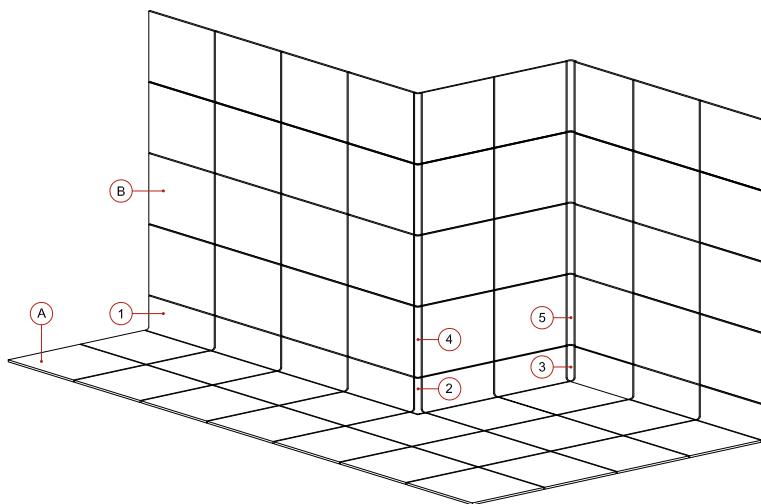

schema A

A pavimento formato cm 20x20 floor size cm 20x20
sol format cm 20x20 boden format cm 20x20

B rivestimento formato cm 20x20 wall tiling size cm 20x20
revetement format cm 20x20 wände format cm 20x20

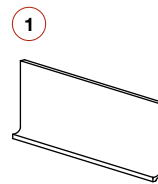

art. zoccolo a raccordo
cm 10x20 - 4"x7⁷/₈"



art. S4
cm 2,5x10 - 1"x4"



art. A4
cm 2,5x10 - 1"x4"

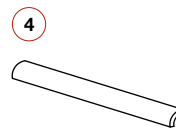

art. S5 sguscetta picc.
cm 2,5x20 - 1"x7⁷/₈"

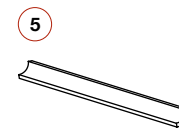

art. A5 sguscetta picc.
cm 2,5x20 - 1"x7⁷/₈"

PEZZI SPECIALI TRIMS ACCESSOIRES FORMSTÜCKE

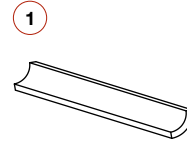
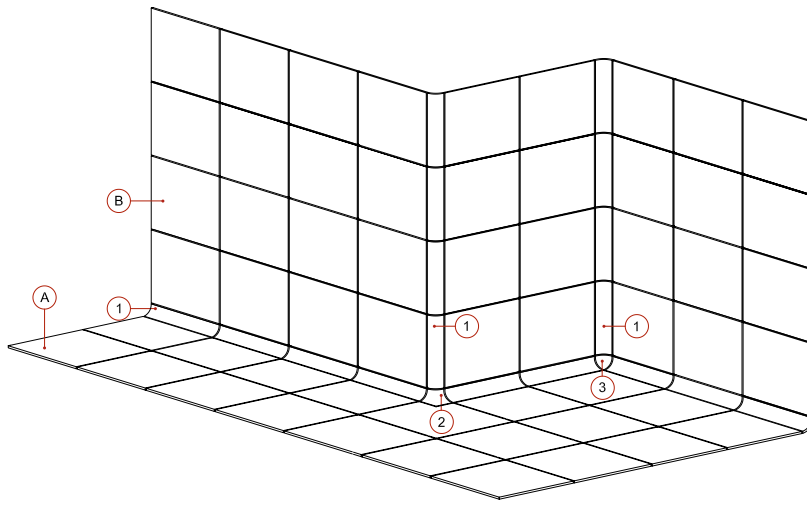

art. sguscetta
cm 4x20 - 1⁹/₁₆"x7⁷/₈"



art. S1 piè d'oca
cm 5x7 - 2"x2³/₄"



art. A1 conchiglia
cm 5x5 - 2"x2"

schema B

A pavimento formato cm 20x20 floor size cm 20x20
sol format cm 20x20 boden format cm 20x20

B rivestimento formato cm 20x20 wall tiling size cm 20x20
revetement format cm 20x20 wände format cm 20x20

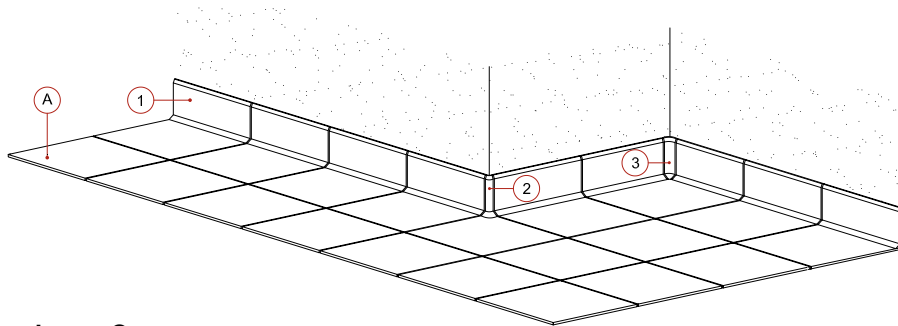

1

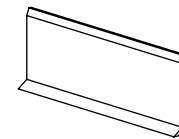

art. zoccolo ad appoggio
cm 10x20 - 4"x7⁷/₈"

2

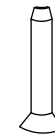

art. S6
cm 2,5x10 - 1"x4"

3



art. A6
cm 2,5x10 - 1"x4"

schema C

A pavimento formato cm 20x20 floor size cm 20x20
sol format cm 20x20 boden format cm 20x20

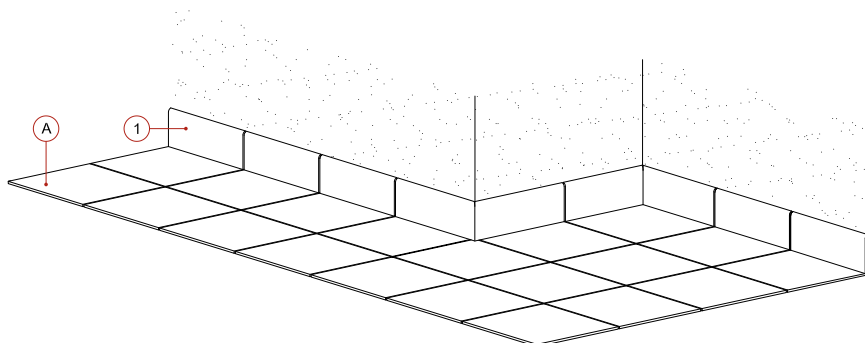

1

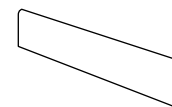

art. battiscopa
cm 10x20 - 4"x7⁷/₈"
cm 9x30 - 3¹/₂"x11³/₄"

schema D

A pavimento formato cm 20x20 o cm 30x30 floor size cm 20x20 or cm 30x30
sol format cm 20x20 or cm 30x30 boden format cm 20x20 oder cm 30x30

technic

GRANITOGRES

SPESSORI THICKNESSES EPAISSEURS STÄRKEN



8 mm

11,2 / 12 mm

14 mm

CARATTERISTICHE TECNICHE TECHNICAL FEATURES

CARACTÉRISTIQUES TECHNIQUES TECHNISCHE EIGENSCHAFTEN



	norma standards norme Norm	risultato prova* test results* résultats des essais* Ergebnisse*
classificazione prodotto product classification classement Klassifizierung	UNI EN 14411-G ISO 13006	gruppo Bla UGL completamente greificato group Bla UGL fully vitrified group Bla UGL grès cérame fin Gruppe Bla UGL Feinsteinzeug
caratteristiche dimensionali e d'aspetto dimensional and surface quality caractéristiques de la surface Oberflächenqualität	UNI EN ISO 10545-2	tolleranze minime nella 1ª scelta very low tolerance des tolérances minimales en 1er choix Entspricht Normen
assorbimento di acqua water absorption absorption d'eau Wasseraufnahme	UNI EN ISO 10545-3	< 0,1%
resistenza alla flessione flexural strength résistance à la flexion Biegezug-Festigkeit	UNI EN ISO 10545-4	45 N/mm ²
resistenza al gelo frost resistance résistance au gel Frostwiderstandsfähigkeit	qualsiasi norma all standards toute norme alle normen	garantita guaranteed garantie Garantiert
resistenza attacco chimico (esclusione acido fluoridrico) resistance to acids and alkalis (with the exception of hydrofluoric acid) résistance à l'attaque chimique (exclusion de l'acide fluorhydrique) Säure und Laugen Beständigkeit (mit Ausnahme von Fluorwasserstoff)	UNI EN ISO 10545-13	A
resistenza usura e abrasione wear and abrasion resistance résistance à l'usure et abrasion Abriebhärte	UNI EN ISO 10545-6	≤ 150 mm ³
dilatazione termica lineare linear thermal expansion coefficient linéaire de dilatation thermique Lineare Wärmeausdehnung	UNI EN ISO 10545-8	6 x 10 ⁻⁶
resistenza alle macchie stain resistance résistance aux taches Fleckenfestigkeit	UNI EN ISO 10545-14	4 - 5 garantita guaranteed garantie Garantiert
resistenza alla scivolosità (Superficie Naturale) slip resistance (Matt surface) résistance au glissement (Surface naturelle) Trittsicherheit (Natur Oberflächen)	DIN 51130 D.M. N° 236 DEL 14.06.89 METODO B.C.R. BS7976-2:2002 BSEN13036-4:201	Roccia R11 A+B Secura R11 A+B Bugnato R11 A+B+C Technic R10 Profil R12 A+B+C Carbo R12 Pavé R11 A+B+C Reticolo R12 A+B+C Safe R13 A+B+C valore $\mu > 0,40$ *** PTV > 36***
resistenza dei colori alla luce colour resistance to sunlight exposure résistance de la couleur à la lumière Unveränderlichkeit der Farben wenn Strahlung zugesetzt wird	DIN 51094	nessuna variazione no change of colours couleurs inchangées Keinerlei Farbänderung

* valore indicativo approx value donnée approximative Ungefähre Werte

** si rimanda all'elenco prodotti UPEC ufficiale, consultabile sul sito: please see the official UPEC product list:

veuillez consulter la liste officielle produits UPEC: sihe die offizielle UPEC-Produktliste auf der Website: <http://webapp.cstb.fr/upec-ceramique/>

*** prova su superficie asciutta test on a dry surface essai sur surface sèche Test auf trockener Oberfläche

Al pari dei materiali naturali di riferimento, l'aspetto estetico, la differenza di tono e le venature possono essere diverse da piastrella a piastrella. Per una corretta comprensione della variabilità del prodotto è consigliabile prendere visione delle immagini a tutto ambiente sul catalogo di collezione, sul nostro sito all'indirizzo www.casalgrandepadana.it o chiedere maggiori informazioni ai nostri concessionari.

Just like the natural materials they are inspired by, the aesthetics, colouration and veining of the tiles can differ. To properly gauge the suitability of a product, we advise that you view the full-space photos that you can find in our collection catalogue and on our website at www.casalgrandepadana.com. Alternatively, please ask a reseller for more information.

Tout comme pour les matières naturelles de référence, la différence de tonalité, les veines ainsi que l'aspect esthétique peuvent varier d'une dalle à l'autre. Pour bien comprendre la variabilité du produit, il est conseillé de consulter les images d'ambiance présentes sur le catalogue de la collection, sur notre site à l'adresse www.casalgrandepadana.fr ou de demander plus d'informations à nos concessionnaires.

Wie bei den als Vorbild dienenden Naturmaterialien können sich auch hier das ästhetische Erscheinungsbild, der Farbtonunterschied und die Maserung von Fliese zu Fliese unterscheiden. Um die Variabilität des Produkts besser zu verstehen, raten wir Ihnen, die Bilder mit ausgestatteten Räumen im Kollektionskatalog auf unserer Website www.casalgrandepadana.de zu konsultieren. Weitere Informationen können Sie auch bei unseren Vertragshändlern erhalten.



CASALGRANDE
PADANA
THE GREEN WAY TO PAVE

via Statale 467, n. 73 - 42013 Casalgrande (Re) Italy
tel + 39 0522 9901 - fax + 39 0522 996121
info@casalgrandepadana.it - www.casalgrandepadana.com

